



MAX1645B Evaluation Kit/Evaluation System

General Description

The MAX1645B evaluation kit (EV kit) is an efficient, multichemistry battery charger. It uses the Intel System Management Bus (SMBus™) to control the battery regulation voltage, charger current output, and input current-limit set point.

The MAX1645B EV kit can charge one, two, three, or four series Li+ cells with a current up to 3A.

The MAX1645B evaluation system (EV system) consists of a MAX1645B EV kit and the Maxim SMBUSMON board. The MAX1645B EV kit includes Windows® 95-/98/2000-/XP-compatible software to provide a user-friendly interface.

EV System

DESIGNATION	QTY	DESCRIPTION
None	1	MAX1645B EV kit
None	1	SMBUSMON Interface

Features

- ◆ Charges Any Battery Chemistry: Li+, NiCd, NiMH, Lead Acid, etc.
- ◆ SMBus-Compatible 2-Wire Serial Interface
- ◆ 3A (max) Battery Charge Current
- ◆ Up to 18.4V Battery Voltage
- ◆ Up to +28V Input Voltage
- ◆ Easy-to-Use Software Included
- ◆ Proven PC Board Layout
- ◆ Fully Assembled and Tested Surface-Mount Board

Ordering Information

PART	TEMP RANGE	IC PACKAGE
MAX1645BEVKIT	0°C to +70°C	28 QSOP
MAX1645BEVSYS	0°C to +70°C	28 QSOP

EV Kit Component List

DESIGNATION	QTY	DESCRIPTION
C1, C2	2	22µF, 35V low-ESR tantalum caps AVX TPSE226M035R0300
C3, C4	2	22µF, 25V low-ESR tantalum caps AVX TPSD226M025R0200
C5, C19, C20	3	1µF, 50V ceramic capacitors (1210) Murata GRM42-2X7R105K050
C6, C7, C12	3	1µF, 10V ceramic capacitors (0805) Taiyo Yuden LMK212BJ105MG
C8, C14, C15, C16	4	0.1µF, 16V ceramic capacitors (0603) Taiyo Yuden EMK107BJ104MA
C9, C10, C11	3	0.01µF ceramic capacitors (0603)
C13	1	1500pF ceramic capacitor (0603)
C18, C23, C24	3	0.1µF, 50V ceramic capacitors (0805) Taiyo Yuden UMK212BJ104MG
D1, D2	2	40V, 2A Schottky diodes Central Semiconductor CSMH2-40
D3, D4	2	Schottky diodes (SOT23) Central Semiconductor CMPSH-3

DESIGNATION	QTY	DESCRIPTION
H1	1	2x10 right-angle female header
H2	1	5-element terminal block
JU1, JU2, JU3	3	2-pin headers
L1	1	22µH, 3.6A inductor Sumida CDRH127-220
LED1	1	Red LED
N1	1	30V, 11.5A N-channel MOSFET Fairchild FDS6680
N2	1	30V, 8.4A N-channel MOSFET Fairchild FDS6612A
P1, P2	2	30V, 11A P-channel MOSFETs Fairchild FDS6675
R1	1	0.040Ω ±1%, 0.5W resistor Dale WSL-2010/0.040Ω/1%
R2	1	0.050Ω ±1%, 0.5W resistor Dale WSL-2010/0.050Ω/1%
R3, R4	2	100kΩ ±1% resistors (0603)
R5, R7, R9, R10, R17	5	10kΩ ±5% resistors (0603)
R6	1	10kΩ ±1% resistor (0603)

SMBus is a registered trademark of Intel Corp.

Windows 95/98 are registered trademarks of Microsoft Corp.



For pricing, delivery, and ordering information, please contact Maxim/Dallas Direct! at 1-888-629-4642, or visit Maxim's website at www.maxim-ic.com.

MAX1645B Evaluation Kit/Evaluation System

EV Kit Component List (cont.)

DESIGNATION	QTY	DESCRIPTION
R8, R13	2	1kΩ ±5% resistors (0603)
R11, R16	2	1Ω ±5% resistors (0603)
R12	1	33Ω ±5% resistor (0603)
R14, R15	2	4.7Ω ±5% resistors (0603)
U1	1	MAX1645BEEI (28-pin QSOP)
None	3	Shunts (JU1, JU2, JU3)
None	1	MAX1645B EV kit software CD

Component Suppliers

SUPPLIER	PHONE	FAX
AVX	803-946-0690	803-626-3123
Central Semiconductor	516-435-1110	516-435-1824
Dale	402-564-3131	402-563-6418
Fairchild	408-822-2000	408-822-2102
Murata	814-237-1431	814-238-0490
Sumida	847-956-0666	847-956-0702
Taiyo Yuden	408-573-4150	408-573-4159

Note: Please indicate that you are using the MAX1645B when contacting the above component suppliers.

Quick Start

Recommended Equipment

- DC source to supply the input current to the charger. This source must be capable of supplying a voltage greater than the battery-voltage set point and have sufficient current rating.
- Voltmeter
- Smart battery
- Computer running Windows 95, 98, 2000, or XP
- 9-pin serial extension cable
- SMBUSMON board

Procedure

The MAX1645B EV kit is a fully assembled and tested board. Follow the steps below to verify board operation. **Do not turn on the power supply until all connections are completed. Observe all precautions on the battery manufacturer's data sheet.**

- 1) Set the VPP jumper on the SMBUSMON board to VCC5.

Table 1. Jumper Functions

JUMPER	STATE	FUNCTION
JU1	Closed*	SCL pulled up to V _{DD} through a 10kΩ resistor.
	Open	SCL not pulled up to V _{DD} ; SCL must be pulled up to external supply.
JU2	Closed*	SDA pulled up to V _{DD} through a 10kΩ resistor.
	Open	SDA not pulled up to V _{DD} ; SDA must be pulled up to external supply.
JU3	Closed*	10kΩ resistor connected between thermistor and ground nodes, simulating the attachment of a smart battery.
	Open	10kΩ resistor disconnected; for use when an actual smart battery will be connected to the EV kit.

*Indicates default jumper setting

- 2) Carefully connect the boards by aligning the 20-pin connector of the MAX1645B EV kit with the 20-pin header of the SMBUSMON board. Gently press them together.
- 3) Connect a cable from the computer's serial port to the SMBUSMON interface board. Use a straight-through 9-pin female-to-male cable.
- 4) Install the software by running the **INSTALL.EXE** program. The install program copies the files and creates icons for them in the Windows 95/98/2000/XP start menu. An uninstall program is included with the software. Click on the UNINSTALL icon to remove the EV kit software from the hard drive.
- 5) Connect power to the SMBUSMON board.
- 6) Connect the input-current supply across the ADAPTER_IN and PGND pads.
- 7) Connect a smart battery to connector H2.
- 8) Turn on the power supply.
- 9) Start the MAX1645B EV kit software.
- 10) Verify current is being delivered to the battery.

MAX1645B Evaluation Kit/Evaluation System

Evaluate: MAX1645B

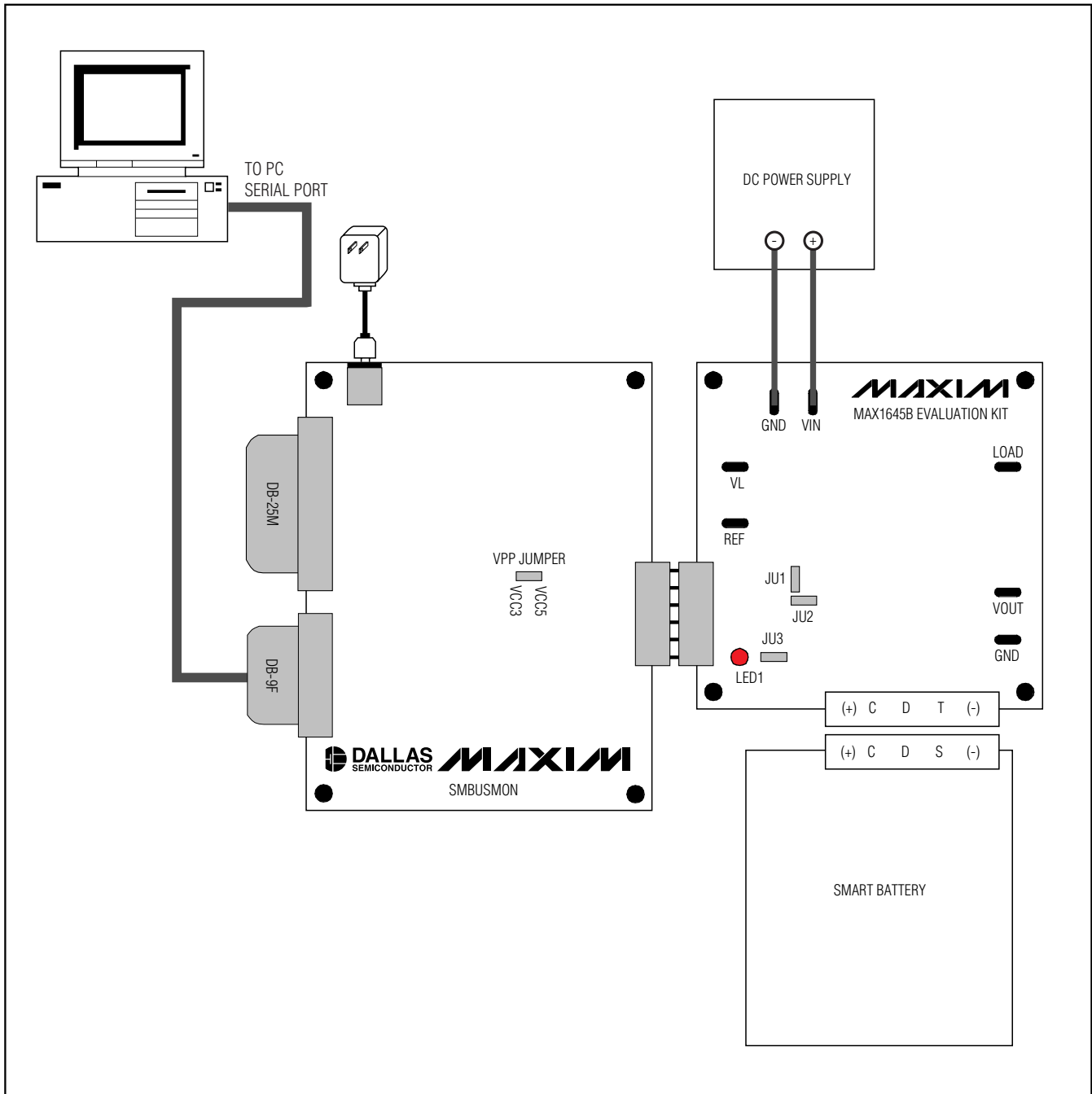

Figure 1. Block Diagram of MAX1645B EV System

MAX1645B Evaluation Kit/Evaluation System

__Detailed Description of Software

The MAX1645B program provides easy access to the MAX1645B registers. It is also capable of reading the registers of a smart battery and monitoring SMBus traffic.

Upon execution of the program, the software enables the MAX1645B smart-charger command panel (Figure 2), after which any of the allowed SMBus commands can be sent to the MAX1645B. Refer to the MAX1645B data sheet for more information regarding the allowed SMBus commands.

Smart-Charger Command Panel

ChargeVoltage()

To issue the ChargeVoltage() command to the MAX1645B, enter the desired voltage, in millivolts, into the Charging Voltage edit field and select the adjacent **Write** button.

ChargeCurrent()

To issue the ChargeCurrent() command to the MAX1645B, enter the desired current, in milliamps, into the Charging Current edit field and select the adjacent **Write** button.

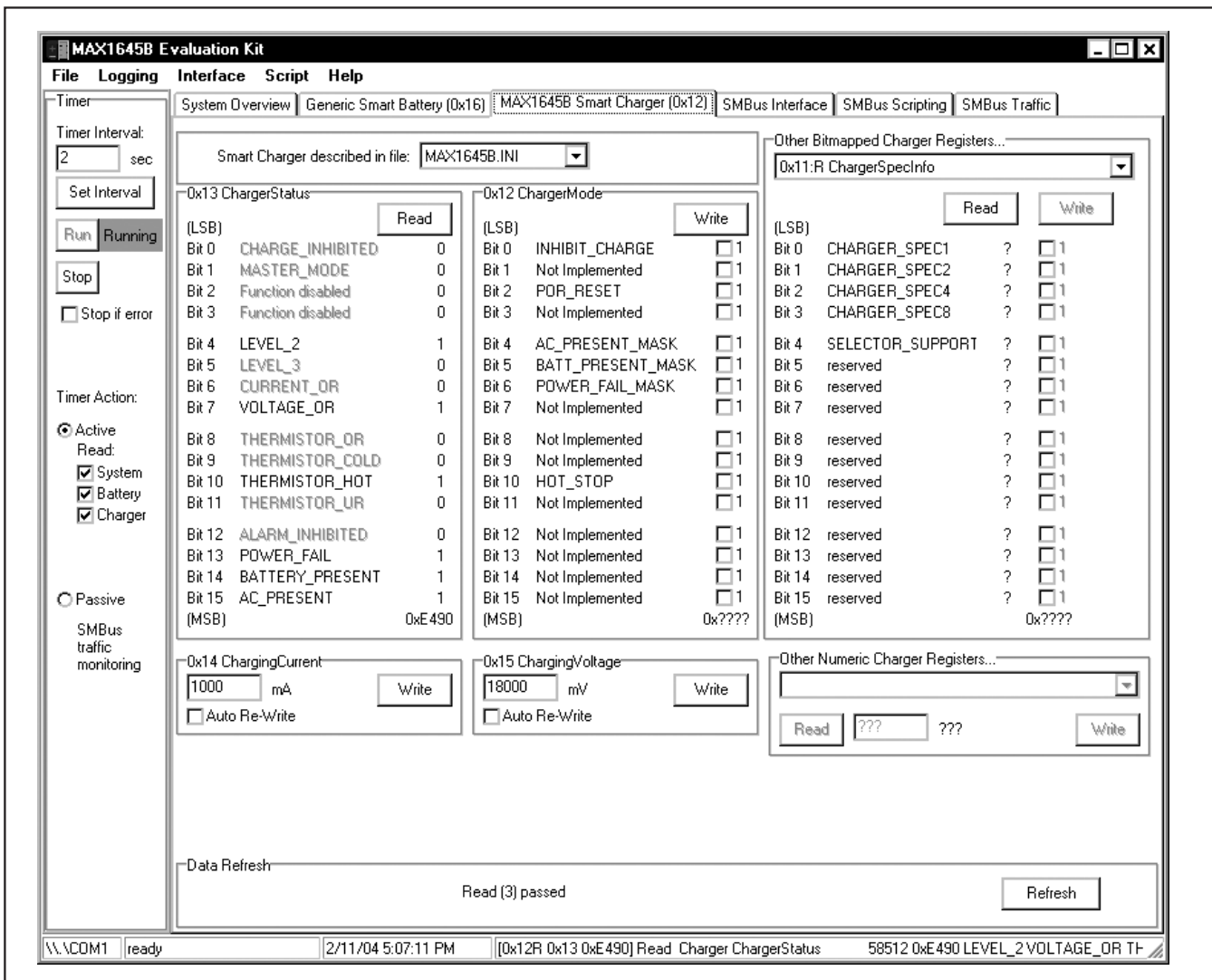

Figure 2. MAX1645B Smart-Charger Command Panel

MAX1645B Evaluation Kit/Evaluation System

Evaluate: MAX1645B

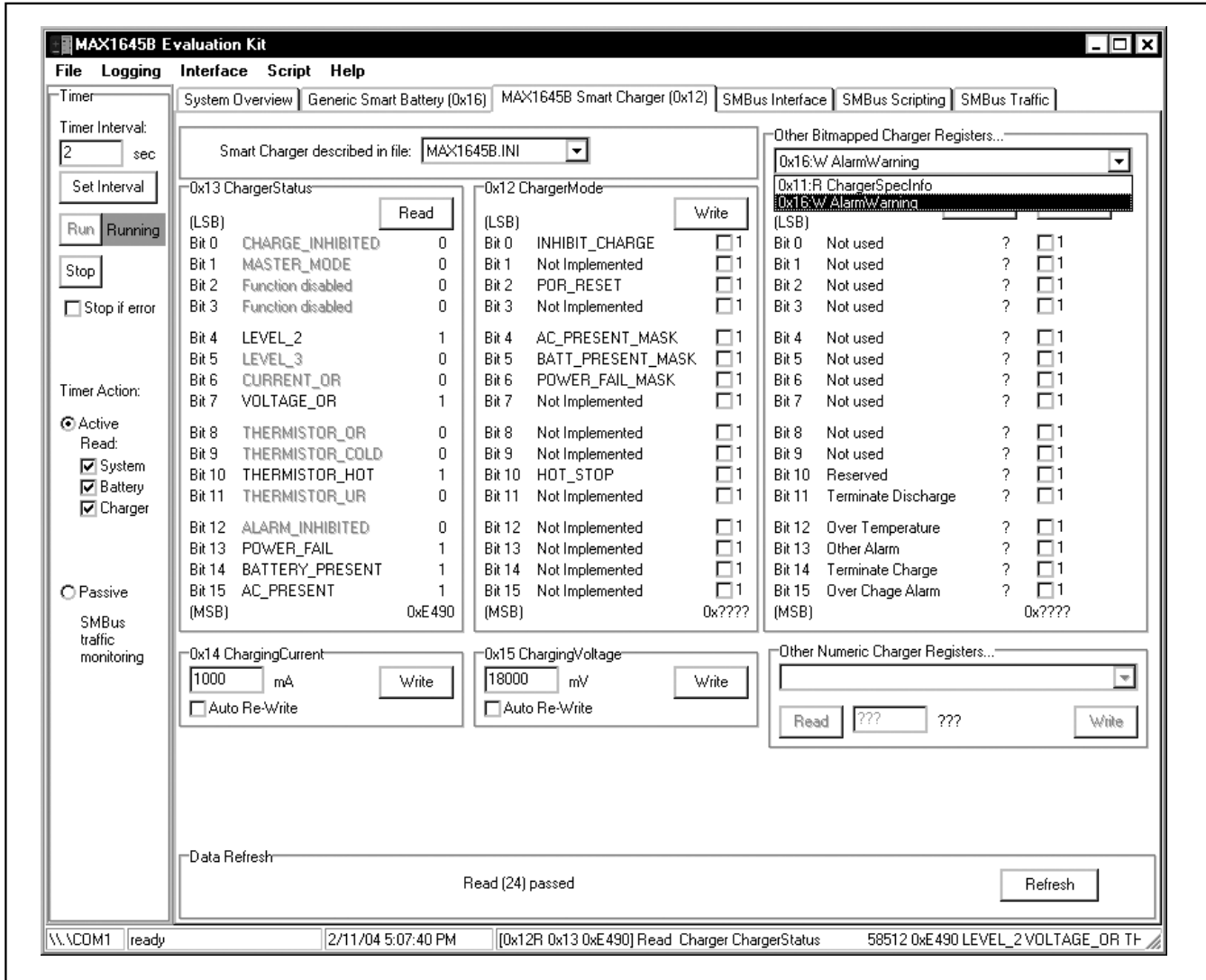

Figure 3. MAX1645B Smart-Charger Command Panel Showing the Pulldown List For Charger Spec Info and Alarm Warning

Auto Rewrite Checkboxes

The MAX1645B needs to receive a ChargeVoltage() or ChargeCurrent() command every 175s (typ); otherwise, the MAX1645B times out and terminates charging. Usually, a smart battery sends these necessary commands. However, when not using a smart battery with the MAX1645B EV kit, select either (or both) of the Auto Rewrite checkboxes located directly under the Charging Current and Charging Voltage edit fields. This generates a ChargeVoltage() or ChargeCurrent() command at the selected time interval located on the Timer panel.

ChargerMode()

To issue the ChargerMode() command to the MAX1645B, select a combination of checkboxes in the Charger Mode panel of commands. Each checkbox represents a bit in the ChargerMode() command word. Select the checkboxes next to the bits for which the software should write a 1, unselect the checkboxes for a 0. Send the command by selecting the **Write** button.

MAX1645B Evaluation Kit/Evaluation System

ChargerStatus()

Charger status is shown in the Charger Status panel. Each of the bits in the ChargerStatus() command word are shown individually with a short description of the bit.

By default, the status is automatically read once every two seconds. Disable this feature by unselecting the Active Read: Charger checkbox located on the Timer panel. Change the refresh time by entering a new value into the Timer Interval edit box and select the **Set Interval** button. When Auto Refresh is disabled, issue a ChargerStatus() command by selecting the **Read** button on the Charger Status panel.

ChargerSpecInfo()

ChargerSpecInfo() returns the Charger Specification (0x0009) from the MAX1645B. This command is available through the “Other Bitmapped Charger Registers...” panel. Select Charger Spec Info by picking it from the pulldown list located directly under the Other Bitmapped Charger Registers... label. Issue a ChargerSpecInfo() command by selecting the **Read** button. The returned hexadecimal value is shown at the bottom of the panel.

AlarmWarning()

Alarm Warning is shown on the Other Bitmapped Charger Registers... panel (Figure 3). Select Alarm Warning by picking it from the pulldown list located directly under the Other Bitmapped Charger Registers... label. Each of the bits in the AlarmWarning() command word are shown individually with a short description of the bit and a checkbox. Select the checkboxes next to the bits for which the software should write a 1; unselect the checkboxes for a 0. Send the command to the MAX1645B by selecting the **Write** button.

Smart-Battery Command Panel

The software is capable of reading the registers of a smart battery. The smart battery page of the software is shown in Figure 4. The software only reads the registers selected with checkmarks. By default, the registers are automatically read once every two seconds. Disable this feature by unselecting the Active Read: Battery checkbox located on the Timer panel. Change the refresh time by entering a new value into the Timer Interval edit box and select the **Set Interval** button. When Auto Refresh is disabled, read the battery by selecting the **Refresh** button.

Detailed Description of Hardware

Input Current Limiting

The MAX1645B EV kit is configured to regulate the battery current so that the total V_{IN} input current does not exceed 2.5A. If a load is connected across the LOAD

and GND pads (another system power supply, for example) that would cause the total current from V_{IN} to exceed 2.5A, the MAX1645B will automatically decrease its charging current to regulate the input current to 2.5A. Refer to the MAX1645B data sheet for more information regarding input current limiting.

Connecting a Smart Battery

The MAX1645B EV kit includes a five-element terminal block to facilitate connecting the EV kit to a smart battery. Refer to the smart battery specification to identify the type of smart battery connector suited to your application. Make sure that the EV kit power is turned off, and connect the (+), C, D, T, and (-) terminals from the EV kit board to the smart battery connector using no more than 2 inches of wire. Remove the JU3 shunt, attach a smart battery to the smart battery connector, and turn the EV kit power back on. See Figure 1 if necessary.

Connecting an Electronic Load

If a smart battery is unavailable, an electronic load can be connected across the BATT and GND pads on the MAX1645B EV kit board. Make sure that the EV kit power is turned off before connecting a load. Make sure that JU3 is shunted, making it appear to the MAX1645B as if a smart battery were connected. After the load is connected, program the load in voltage mode and set the electronic load to clamp at 5V. Turn on the power to the EV kit, and program the MAX1645B with a charging voltage of 12V at the maximum charging current. Verify that the MAX1645B is supplying the maximum current to the load. Increase the electronic load clamp voltage in 1V increments, and verify that as the electronic load voltage crosses 12V, the MAX1645B transitions from current regulation to voltage regulation; as the electronic load voltage increases beyond 12V, the BATT voltage should remain fixed at 12V.

Layout Considerations

The MAX1645B EV kit layout is optimized for fast switching and high currents. The traces connecting the power components must be able to carry at least 3A. Take care to ensure that C1 and C2 (the input capacitors), D2 and N2 (the synchronous rectifier), and C3 and C4 (the output capacitors) are all connected to GND at a common point, and to isolate the power GND from the quiet analog GND.

MAX1645B Evaluation Kit/Evaluation System

Evaluate: MAX1645B

MAX1645B Evaluation Kit

File Logging Interface Script Help

System Overview Generic Smart Battery (0x16) MAX1645B Smart Charger (0x12) SMBus Interface SMBus Scripting SMBus Traffic

Smart Battery described in file: BATTERY.INI

Smart Battery Settings

<input checked="" type="checkbox"/> 0x00 Manufacturer Access	0xFF10	<input checked="" type="checkbox"/> 0x10 Full Charge Capacity	1770 mAh
<input checked="" type="checkbox"/> 0x01 Remaining Capacity Alarm	300 mAh	<input checked="" type="checkbox"/> 0x11 Run Time to Empty	2646 minutes
<input checked="" type="checkbox"/> 0x02 Remaining Time Alarm	10 minutes	<input checked="" type="checkbox"/> 0x12 Average Time to Empty	2646 minutes
<input checked="" type="checkbox"/> 0x03 Battery Mode	0x0000 mAh	<input checked="" type="checkbox"/> 0x13 Average Time to Full	65535 minutes
<input checked="" type="checkbox"/> 0x04 At Rate	-256 mA	<input checked="" type="checkbox"/> 0x14 Charging Current	2000 mA
Apply Selected Changes (0x00..0x04 writeable)			
<input checked="" type="checkbox"/> 0x05 At Rate Time to Full	65535 minutes	<input checked="" type="checkbox"/> 0x15 Charging Voltage	65471 mV
<input checked="" type="checkbox"/> 0x06 At Rate Time to Empty	389 minutes	<input checked="" type="checkbox"/> 0x16 Battery Status	0x00C0
<input checked="" type="checkbox"/> 0x07 At Rate OK	true	<input checked="" type="checkbox"/> 0x17 Cycle Count	196 cycles
<input checked="" type="checkbox"/> 0x08 Temperature	294.2 K 21.1 C	<input checked="" type="checkbox"/> 0x18 Design Capacity	3000 mAh
<input checked="" type="checkbox"/> 0x09 Voltage	16105 mV	<input checked="" type="checkbox"/> 0x19 Design Voltage	14800 mV
<input checked="" type="checkbox"/> 0x0A Current	-43 mA	<input checked="" type="checkbox"/> 0x1A Specification Info	0x0010
<input checked="" type="checkbox"/> 0x0B AverageCurrent	-43 mA	<input checked="" type="checkbox"/> 0x1B Manufacture Date	5/13/1999
<input checked="" type="checkbox"/> 0x0C Max Error	20 %	<input checked="" type="checkbox"/> 0x1C Serial Number	24127
<input checked="" type="checkbox"/> 0x0D Relative State of Charge	93 %	<input type="checkbox"/> 0x20 Manufacturer Name	
<input checked="" type="checkbox"/> 0x0E Absolute State of Charge	55 %	<input type="checkbox"/> 0x21 Device Name	
<input checked="" type="checkbox"/> 0x0F Remaining Capacity	1654 mAh	<input checked="" type="checkbox"/> 0x22 Device Chemistry	LION

0x23 Mfg Data { 0x42 0x44 0x59 0x4E 0x41 }

Data Refresh

Refresh Select All Select None Erase old data Use PECs Open CSV Log... Logging On Logging Off Close Log

Read (75) passed <74 good reads> data1og.csv

\\.\COM1 ready 2/11/04 5:09:01 PM [0x12R 0x13 0xE490] Read Charger ChargerStatus 58512 0xE490 LEVEL_2 VOLTAGE_OR TR

Figure 4. MAX1645B Smart-Battery Command Panel

MAX1645B Evaluation Kit/Evaluation System

Evaluate: MAX1645B

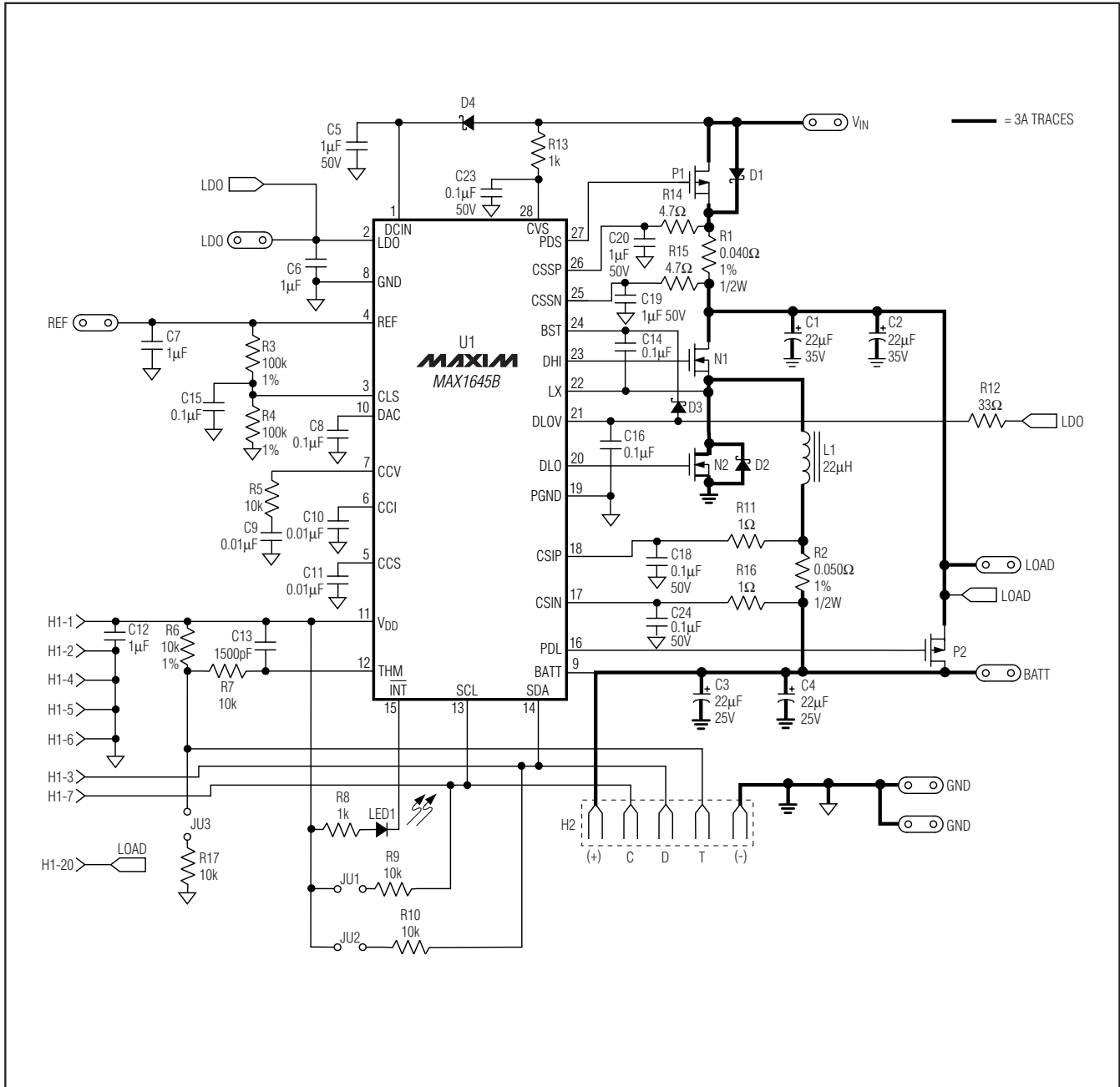

Figure 5. MAX1645B EV Kit Schematic

MAX1645B Evaluation Kit/Evaluation System

Evaluate: MAX1645B

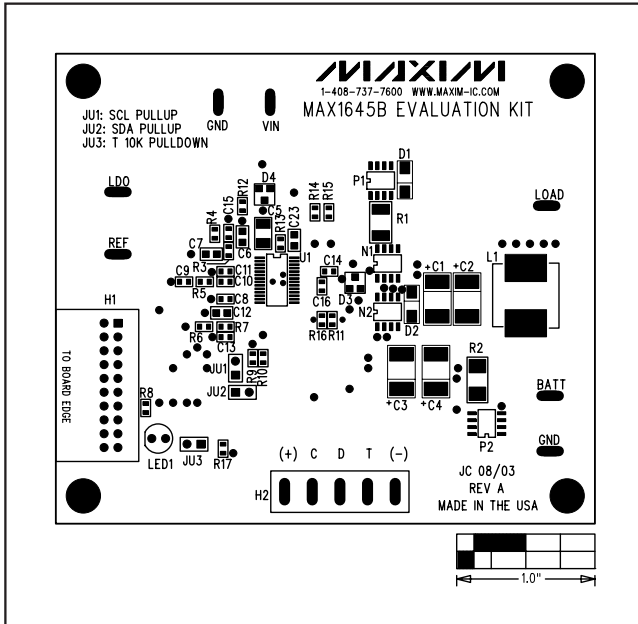

Figure 6. MAX1645B EV Kit Component Placement Guide—Component Side

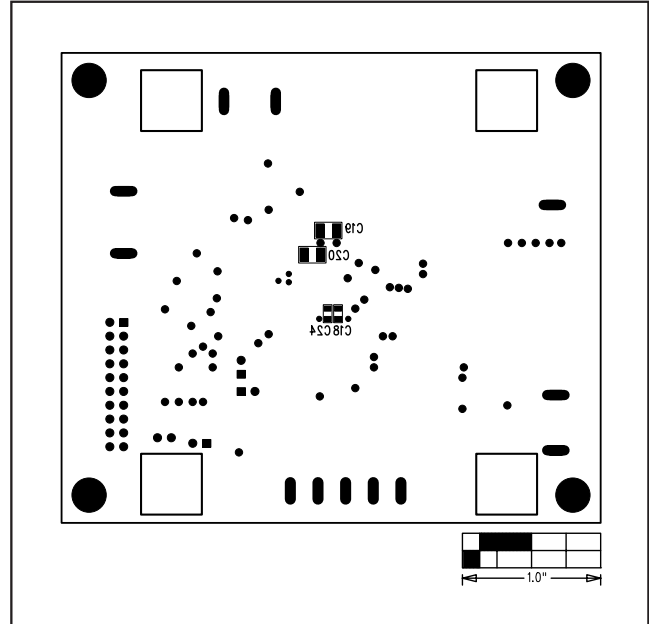

Figure 7. MAX1645B EV Kit Component Placement Guide—Solder Side

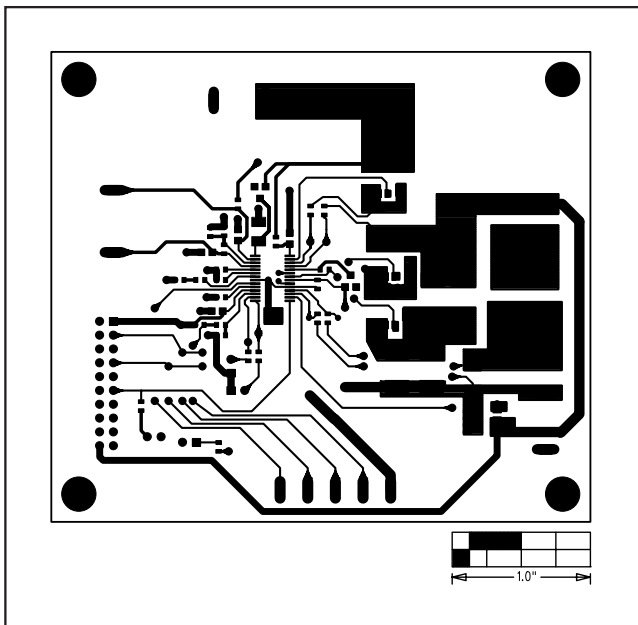

Figure 8. MAX1645B EV Kit PC Board Layout—Component Side

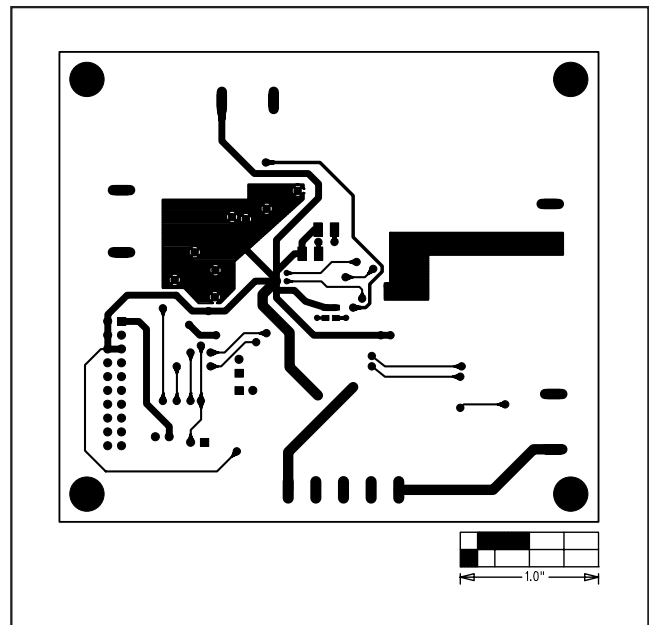

Figure 9. MAX1645B EV Kit PC Board Layout—Solder Side

Maxim cannot assume responsibility for use of any circuitry other than circuitry entirely embodied in a Maxim product. No circuit patent licenses are implied. Maxim reserves the right to change the circuitry and specifications without notice at any time.

Maxim Integrated Products, 120 San Gabriel Drive, Sunnyvale, CA 94086 408-737-7600 _____ 9